

33 800 861



- sporgenza 200 mm
- bocca girevole 360°
- Possibilità di limitarne la rotazione con il set di riduzione 12 820 970 90
- Getto con aria
- portata max 8 l/min a una pressione idraulica di 3 bar
- senza piombo
- Questo prodotto può aiutare un edificio a soddisfare i requisiti dei Green Building Rating Systems, ad es. LEED®, BREEAM®, DGNB

	Cromato	33 800 861-00
	Platinato spazzolato	33 800 861-06
	Platinato	33 800 861-08
	Ottone (Oro 23k)	33 800 861-09
	Dark Chrome	33 800 861-19
	Ottone spazzolato (Oro 23k)	33 800 861-28
	Nero opaco	33 800 861-33
	Champagne spazzolato (Oro 22k)	33 800 861-46
	Champagne (Oro 22k)	33 800 861-47
	Cromo spazzolato	33 800 861-93
	Dark Platinum spazzolato	33 800 861-99

Prodotti complementari

Set limitazione di giro - 12 820 970 90



Prodotti complementari

Comando piletta ad eccentrico con manopola con manopola - Cromato 10 712 970-00



Prodotti complementari

Dispenser senza rosetta - Cromato 82 424 970-00



33 800 861



Diagramma di portata



Certificati

LGA_38642.

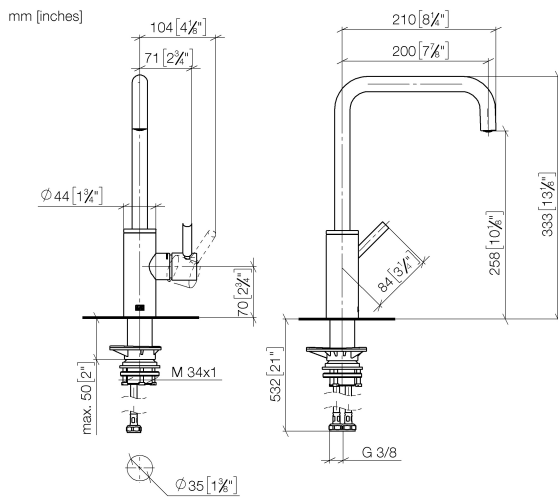
WRAS_240102021.

33 800 861

